

151 Industrial Park Rd
Colborne, ON K0K 1S0
905-355-3281

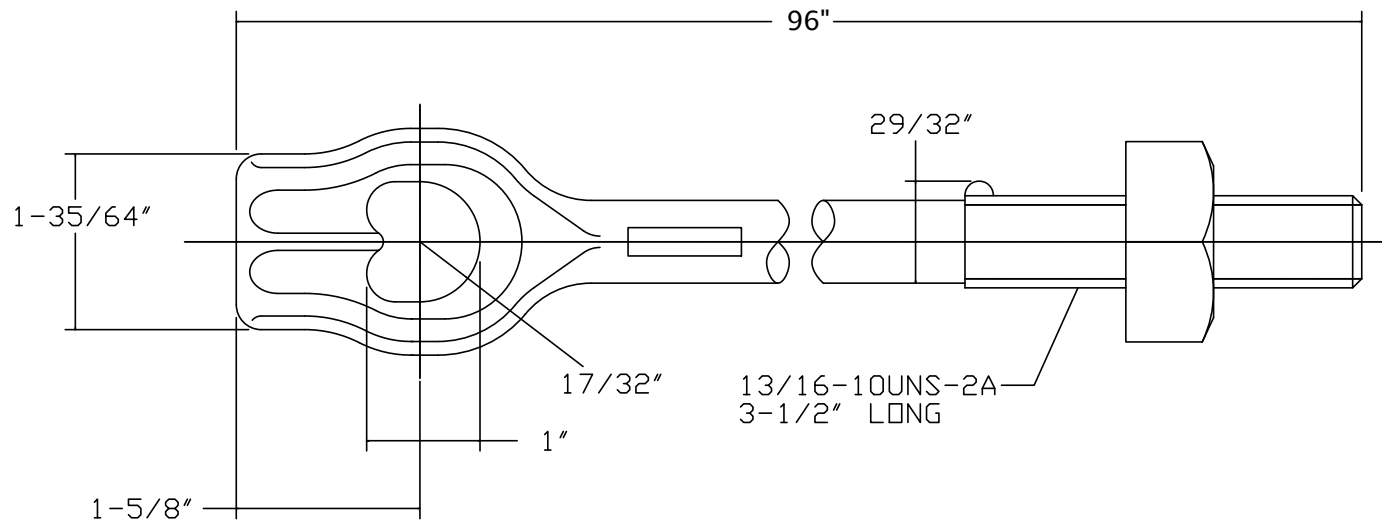
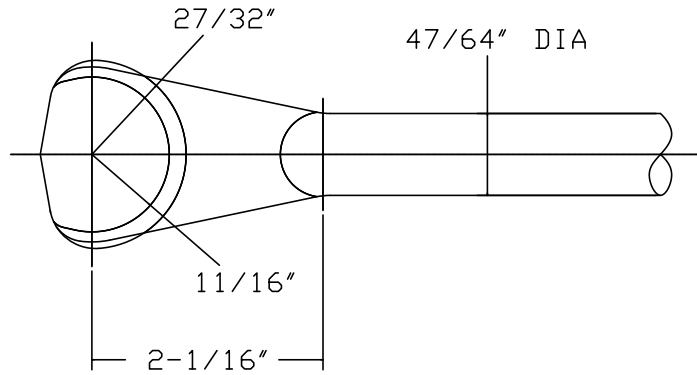

NOTES:

1. HOT DIP GALVANIZED PER ASTM A12
2. ASSEMBLED WITH A HEAVY SQUARE NUT

Anchor Rod, 3/4" x 8', Forged Double Thimble Eye	
Frontier Part Number:	425AR348D